

**David**

**BYWORTH**

**GRAPHIC Designer**

**portfolio**



**kallkwik**<sup>®</sup>  
business design + print

Grab people's attention with Kall Kwik. We can help you make your marketing communications irresistible, with creative solutions as unique as your business.

Whether you want an integrated programme of communication materials, a fresh look for your corporate identity or simply a fast, reliable printer, you can trust us to deliver exactly what you need.

If you'd like to find out how to make expert design and stunning print work to your advantage – get in touch with Kall Kwik today.

**Ⓚ**aptivate  
your audience

54 Alma Street Luton Bedfordshire LU1 2PL  
t: 01582 737772 f: 01582 417018  
e: sales@kkluton.co.uk



Mobile Complimentary Therapist  
Indian Head Massage & Aromatherapy

Sam Coote  
BSYA(arom) AHCR(reg) MANM

Mobile Complimentary Therapist

Overworked?  
Stressed?  
Tired?



Indian Head Massage & Aromatherapy

Discover the benefits of these holistic therapies in the comfort of your own home.

A friendly, qualified practitioner.  
Flexible appointments and locations.  
Treatments to suit your individual needs.

Call Sam now for a FREE consultation 07745 860929

Sam Coote BSYA(arom) AHCR(reg) MANM sam@samcoote.co.uk



a: 103 Hunting Gate, Colchester, Essex, CO1 2XE t: 07745 860929 e: sam@samcoote.co.uk

Client: Sam Coote  
Project: Brand Creation

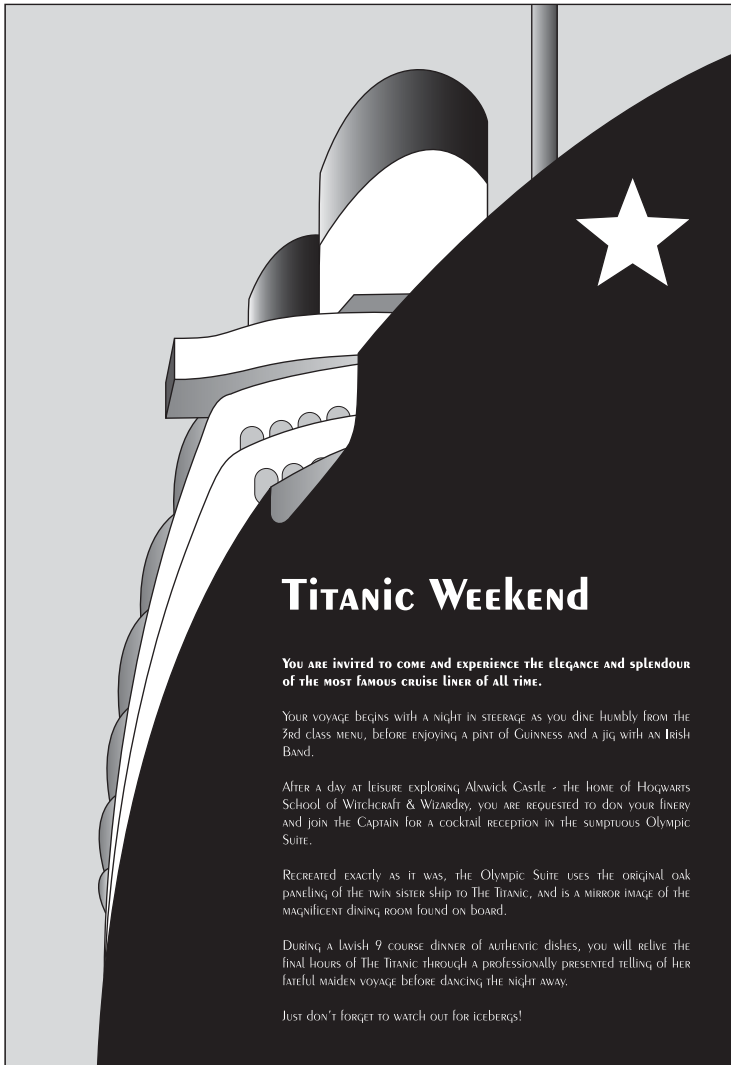

## TITANIC WEEKEND

**YOU ARE INVITED TO COME AND EXPERIENCE THE ELEGANCE AND SPLENDOUR OF THE MOST FAMOUS CRUISE LINER OF ALL TIME.**

YOUR VOYAGE BEGINS WITH A NIGHT IN STEERAGE AS YOU DINE HUMBLY FROM THE 3RD CLASS MENU, BEFORE ENJOYING A PINT OF GUINNESS AND A JIG WITH AN IRISH BAND.

AFTER A DAY AT LEISURE EXPLORING ALNWICK CASTLE - THE HOME OF HOGWARTS SCHOOL OF WITCHCRAFT & WIZARDRY, YOU ARE REQUESTED TO DON YOUR LINEN AND JOIN THE CAPTAIN FOR A COCKTAIL RECEPTION IN THE SUMPTUOUS OLYMPIC SUITE.

RECREATED EXACTLY AS IT WAS, THE OLYMPIC SUITE USES THE ORIGINAL OAK PANELING OF THE TWIN SISTER SHIP TO THE TITANIC, AND IS A MIRROR IMAGE OF THE MAGNIFICENT DINING ROOM FOUND ON BOARD.

DURING A LAVISH 9 COURSE DINNER OF AUTHENTIC DISHES, YOU WILL RELIVE THE FINAL HOURS OF THE TITANIC THROUGH A PROFESSIONALLY PRESENTED TELLING OF HER FAITHFUL MAIDEN VOYAGE BEFORE DANCING THE NIGHT AWAY.

JUST DON'T FORGET TO WATCH OUT FOR ICEBERGS!

The Jeff Short Big Swing Band & Singers

# Big Band

Charity Christmas Ball

Witham Public Hall

4th December 2010  
8pm to 11.30pm



Tickets **£18.50** each

Contact Paul Holmes for more details  
on 07877 495017 or [paul.holmes@mencap.org.uk](mailto:paul.holmes@mencap.org.uk)

Witham Public Hall, Collingwood Road, Witham, CM8 2DY  
Wheelchair Accessible • Parking Nearby • Licensed Bar\* • Bring Your Own Food

Fundraising event in support of



**Support Mencap's campaign for equal healthcare for people with a learning disability**  
Donate online at [www.justgiving.com/bigbandcharitychristmasball](http://www.justgiving.com/bigbandcharitychristmasball)



**POPE**

**Swivel Coupler**

**DOUBLE ACTION**

ROTATION - ROTATION  
**360°**  
ROTATION - ROTATION

180°  
SWIVEL ACTION

## Swivel COUPLER

- Easier to untwist & straighten hose
- Eliminates hose kinking
- Suits 12mm fittings
- Flow rate remains the same
- Rotates 360° when connected to female fittings

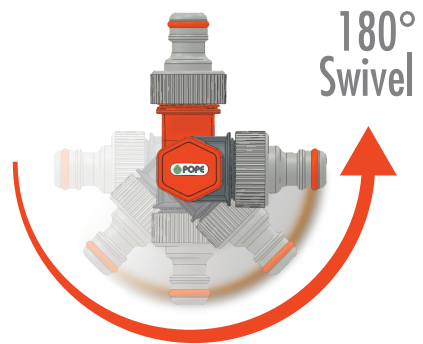
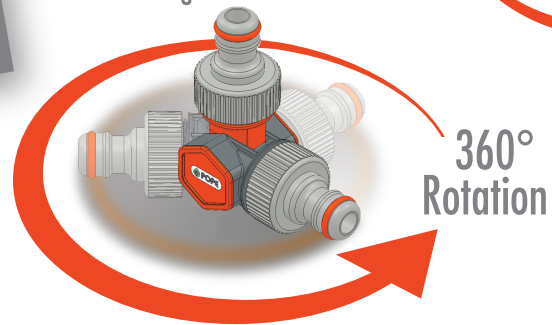

This Pope product has a 1 year guarantee against defects in material and workmanship when used in normal home gardening applications. Our obligation under this guarantee is limited to the replacement of the product at our discretion for a period of 1 year from the date of purchase. In the event of a claim, you must immediately cease using the product and return the product together with your proof of purchase and an explanation of the fault to the store you purchased it from. All costs associated with the return of the product are your responsibility.

Our goods come with guarantees that cannot be excluded under the Australian Consumer Law. You are entitled to a replacement or refund for a major failure and for compensation for any other reasonably foreseeable loss or damage. You are also entitled to have the goods repaired or replaced if the goods fail to be of acceptable quality and the failure does not amount to a major failure.

Made to Toro Australia Pty Limited's specifications in Taiwan.

**TORO Toro Australia**  
 Pope® is a Registered Trademark of  
**Toro Australia Pty Ltd**  
 53 Howards Road, Beverley SA 5009  
 info.au@toro.com  
 1300 134 880  
[www.popeproducts.com.au](http://www.popeproducts.com.au)



1011800





# Pop Up Shelf Ready Display Carton Insert Proposal

Pop ups press down into card insert

Cross section of packaging

Two upper rows held at base by carton insert

3 lower rows sit on bottom of outer carton

Card insert

Display Carton Outer

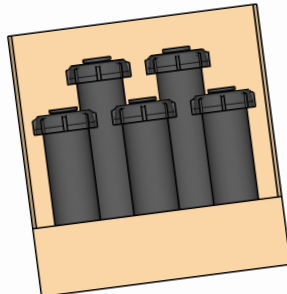
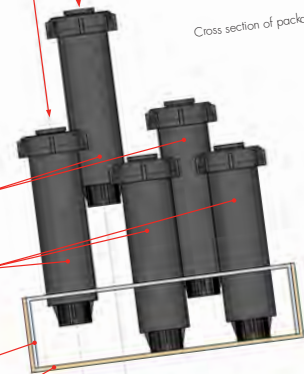

4" Pop Ups in situ

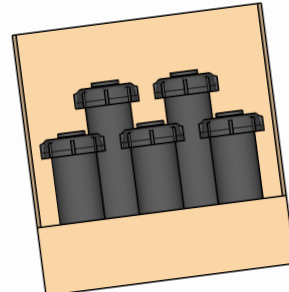

3" Pop Ups in situ

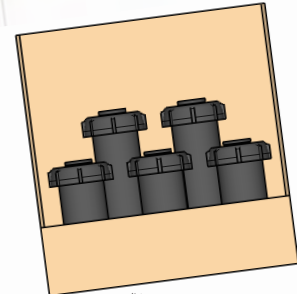

2" Pop Ups in situ

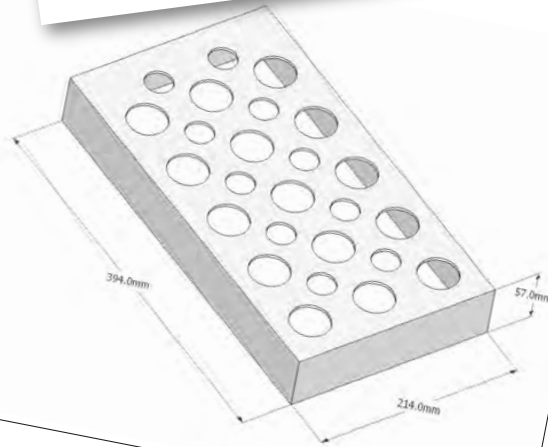
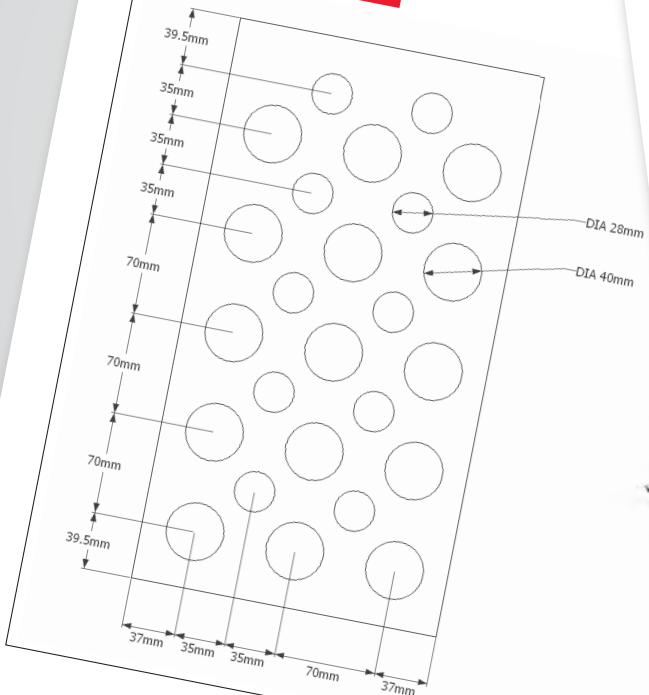

geoff**bickers**photography

 geoff bickers  
PHOTOGRAPHY

g e o f f   b i c k e r s  
PHOTOGRAPER



## Investing in the future of the Motor Industry



About ReMIT	Training for the future	Investing in your future	How the scheme works
<p>ReMIT is the UK's foremost Training Provider to the Retail Motor Industry serving both the industry and the industry. Through our tailored training courses we turn new recruits into skilled employees, confident in any one of a number of retail Motor Industry disciplines. For the sector Apprentices we provide a qualification and recruitment opportunity for other talented prospects in all disciplines of the Motor Industry.</p> <p>With over 8,000 Apprentices nationwide, ReMIT is the country's largest Managing Agent for the Motor Industry. With a wealth of experience in all sectors and cost-effective training solutions to the industry and long term career opportunities for Apprentices.</p> <p>Working with Learning and Skills Councils and Local Enterprise Companies (LECs) and Education Learning Vouchers (ELV's), ReMIT is able to access Government funding which in turn enables us to fund elements of the Apprentices training costs. We will normally pay for the full course, textbooks, registration fees and exam fees, while still in the assessment process. Thanks to our expert knowledge of Government Funding procedures, ReMIT is able to provide training at no direct cost to the employer.</p> <p><b>Courses available:</b></p> <ul style="list-style-type: none"> <li>Light Vehicle Technician</li> <li>Customer Service</li> <li>Heavy Vehicle</li> <li>Administration</li> <li>Motorcycle Technician</li> <li>Vehicle Body Repair</li> <li>Parts Supplies</li> <li>Vehicle Painter</li> <li>Vehicle Sales</li> <li>Valuer</li> </ul>	<p>As a national organisation, ReMIT is able to buy training from an established provider to suit your needs. We know where the best Colleges are and the courses they offer. We advise an employer of all the options available and organise the most suitable choice.</p> <p>ReMIT supports both employer and employee throughout the training period, making regular visits to the workplace to ensure that the Apprentice is progressing as intended.</p> <p>A ReMIT Training Coordinator combines an assessment and review visit, to ensure the Apprentice is provided with the training specified in their Individual Training Plan. The assessment profile review sheet will record any necessary adjustments to the Apprentice's programme and may necessitate the issue of a revised Individual Training Plan.</p> <p>An Apprentice Technician could be at least 35% productive after the first year of training, working up to 35 hours a week. By the end of the training period it is worth remembering that, as well as the direct benefits a Apprentice brings to a company within a short space of time, the added benefit provided may mean trained technicians to carry out other productive work. Mechanical Apprentices, such as Recruiters or Administrators may be productive in a shorter time-span.</p>	<p>Today, the Motor Industry can truly be said to drive continuous growth without much need to be uncertain. What happens though, if that industry does not invest in its employees? Over a period of time, a real skills shortage may develop, making it increasingly difficult, and expensive, to find the right people.</p> <p>ReMIT works with both the industry and the individual Apprentices to ensure the future of the Motor Industry. Without them, investing in future growth can be an expensive and frustrating exercise.</p> <p>Typically, the employer commits to hiring an Apprentice as an employee. This allows increased flexibility regarding working hours and conditions. It also enables the Apprentice to earn a salary while completing their qualifications.</p>	<p>ReMIT training programmes are suitable for companies with a large workforce or with just two or three people. For its part, the employer's commitment is to the future growth of its business. For the employer, a ReMIT Apprentice and the individual's drive and determination finds its own rewards in a career within one of the world's foremost industries.</p> <p>Each Apprentice embarks on a detailed Individual Training Plan which is agreed in advance with the employer, because we recognise that not all people are the same, or work in the same way, the plan is reviewed on specific dates and amended if necessary. This allows both the Apprentice and the Employer to record progress and enables decisions to be made at the review stage. An Apprentice, who is employed by an organisation, can be taught exactly how the organisation wants them to behave, the system is sound and the specialist advice they want them to have.</p> <p>A Training Evidence Record Book is also maintained, the contents of which are based on standards which have been set for the industry by the Motor Industry Training Standards Council. These are included in the book together with examples of work tasks associated with the standards.</p>

**Supervision and Assessment**

Supervisors assist in the training process by providing a Witness Book, which means that they are satisfied that Apprentices have the ability to carry out the tasks unassisted. The Assessment Record acts as supplementary evidence that Apprentices are competent in a task or group of tasks.

As a further record of competence, all Apprentices are issued with an Induction Checklist so that they can ensure that all necessary subjects have been covered in training. A Q&A Web Record is provided to assist Apprentices evaluate their training during the first ten weeks of their programme.

Part of ReMIT's responsibility as a Managing Agent is to visit the garage and the Apprentice on a regular basis. Feedback from the Apprentice's Manager is sought at these visits, allowing regular opportunities to discuss any problems that arise.

**Qualifications**

ReMIT can assist with the selection of an Apprentice or work with an organisation's existing applicants and employees. Because ReMIT runs Apprenticeship Training and that leading to ReMIT is the ultimate achievement of a National Vocational Qualification (NVQ), or Scottish National Vocational Qualification (SNVQ) it is in our interest to match suitable candidates to companies. To assist in this, each potential candidate undergoes a detailed interview and assessment before a suitable Company is approached for interview.

The training process itself works on a day or block release system. Apprentices attend a Local Training Centre or College to gain practical skills and the underpinning knowledge needed to do the job. A Foundation Apprenticeship (NVQ) level 1 lasts for two and a half years. A Modern Apprenticeship (NVQ) level 2 lasts a year longer and we recommend that all Apprentices work to the level that suits their current abilities. All qualifications include underpinning knowledge and practical area and all work completed is assessed by a ReMIT Assessor in the workplace to keep you on track.

**Investing in your future**

ReMIT provides:

- Training for the Retail Motor Industry
- Over 60 years experience
- Ongoing assessment and review
- Funded off-peak training
- Advice and support with recruitment

**How the scheme works**

ReMIT provides:

- Training for the Retail Motor Industry
- A wide range of programmes nationally
- College funding for Apprentices
- A Personal Training Programme
- A Personal Training Coordinator
- A National Vocational Qualification (NVQ or similar)



# NEWS DIMENSIONS

March

www.molecular

# NEWS DIMENSIONS

Issue 2

## SPINE Delivers Major New Screen

www.moleculardimensions.com

The screen was developed by James Newman, and was tested in the laboratory of Masahiko Terada at the Iwate University, Japan, as part of the SPINE programme, and it is now available for sale by Molecular Dimensions.

PACT premier is a 96-well microtitre plate with a PEG-coated bottom. It is used to test the effect of various conditions on protein crystallization. The screen is available in a 96-well microtitre plate format, and is used to test the effect of various conditions on protein crystallization. The screen is available in a 96-well microtitre plate format, and is used to test the effect of various conditions on protein crystallization.

The screen is available in a 96-well microtitre plate format, and is used to test the effect of various conditions on protein crystallization. The screen is available in a 96-well microtitre plate format, and is used to test the effect of various conditions on protein crystallization. The screen is available in a 96-well microtitre plate format, and is used to test the effect of various conditions on protein crystallization.

The screen is available in a 96-well microtitre plate format, and is used to test the effect of various conditions on protein crystallization. The screen is available in a 96-well microtitre plate format, and is used to test the effect of various conditions on protein crystallization. The screen is available in a 96-well microtitre plate format, and is used to test the effect of various conditions on protein crystallization.

The screen is available in a 96-well microtitre plate format, and is used to test the effect of various conditions on protein crystallization. The screen is available in a 96-well microtitre plate format, and is used to test the effect of various conditions on protein crystallization. The screen is available in a 96-well microtitre plate format, and is used to test the effect of various conditions on protein crystallization.

## LithoLoops™ Mounted loops you can trust!

Since the first description of the cryo-loop mounting method (Terada T-Y, J Appl Cryst 1990, 23:380-391) alternative cryo-loop mounting methods have been developed. LithoLoops™ have become a standard tool for cryo-crystallography. They are easy to use and not tedious to make, and they are available in a wide range of sizes. Many users have dreamed of the day when a manufacturing process could loop up a protein and render it machine-dimensioned. Protein Wave Corp. (Usam) has developed such a process based on lithography, and has exclusively licensed the LithoLoops™ to Molecular Dimensions™ for international sale.

LithoLoops are etched from a Mylar™ film allowing for very precise and reproducible diameters and these loops do not unwind. LithoLoops display negligible diffraction (even when the stem is hit directly by the X-ray beam) who does not affect data processing. LithoLoops are mechanically stable under the vacuum stream (do not bend during the data collection).

LithoLoops are strong enough to carry crystals of 0.3mm. LithoLoops are more rigid than previously possible on cryo. The thickness and size of the drop suspended in the loop is less than in the original nylon loops, reducing the background and improving the I/sig.

It is easy to loop up individual LithoLoops from the film by picking up the loop with tweezers. This will not leave anything on the loop, because the weight of the bar and stem body are evenly separated from film. If the user wishes a film any remaining on the sag this can easily be achieved with a microtite or chisel from a Micro Tool set.

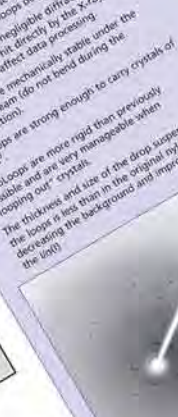

**Mounted LithoLoops**  
LithoLoops are available mounted on a standard 18 mm stainless steel pin. The pin has an outside diameter of 0.635 mm to fit into the standard hole on mounting systems. The distance from the loop to pin is highly reproducible.

**PACT premier HT-95**  
This powerful, new crystal growth screen is also available in convenient 96-well microtitre plates for robotic or manual dispensing into 96-well crystal growth trays. Each 96-well screen is presented in a 1ml drop-well block sealed with a polypropylene, non-purged, air-tight stopper. The stopper is made of high quality polypropylene and is highly reproducible.

**Mounted LithoLoops**  
LithoLoops are available mounted on a standard 18 mm stainless steel pin. The pin has an outside diameter of 0.635 mm to fit into the standard hole on mounting systems. The distance from the loop to pin is highly reproducible.

**Mounted LithoLoops**  
LithoLoops are available mounted on a standard 18 mm stainless steel pin. The pin has an outside diameter of 0.635 mm to fit into the standard hole on mounting systems. The distance from the loop to pin is highly reproducible.

**Mounted LithoLoops**  
LithoLoops are available mounted on a standard 18 mm stainless steel pin. The pin has an outside diameter of 0.635 mm to fit into the standard hole on mounting systems. The distance from the loop to pin is highly reproducible.

**Mounted LithoLoops**  
LithoLoops are available mounted on a standard 18 mm stainless steel pin. The pin has an outside diameter of 0.635 mm to fit into the standard hole on mounting systems. The distance from the loop to pin is highly reproducible.

**Mounted LithoLoops**  
LithoLoops are available mounted on a standard 18 mm stainless steel pin. The pin has an outside diameter of 0.635 mm to fit into the standard hole on mounting systems. The distance from the loop to pin is highly reproducible.

## CrystalPro™ IN CRYSTAL IMAGING SYSTEM

CrystalPro introduces a visualising protein experiments



CrystalPro introduces a visualising protein experiments. The system is designed to provide a clear view of the crystal growth process. It features a high-resolution camera and a computer interface that allows the user to monitor the growth of individual crystals in real-time. The system is easy to use and provides a wide range of options for data collection and analysis.

The system is designed to provide a clear view of the crystal growth process. It features a high-resolution camera and a computer interface that allows the user to monitor the growth of individual crystals in real-time. The system is easy to use and provides a wide range of options for data collection and analysis.

CrystalPro introduces a visualising protein experiments. The system is designed to provide a clear view of the crystal growth process. It features a high-resolution camera and a computer interface that allows the user to monitor the growth of individual crystals in real-time. The system is easy to use and provides a wide range of options for data collection and analysis.

The system is designed to provide a clear view of the crystal growth process. It features a high-resolution camera and a computer interface that allows the user to monitor the growth of individual crystals in real-time. The system is easy to use and provides a wide range of options for data collection and analysis.

CrystalPro introduces a visualising protein experiments. The system is designed to provide a clear view of the crystal growth process. It features a high-resolution camera and a computer interface that allows the user to monitor the growth of individual crystals in real-time. The system is easy to use and provides a wide range of options for data collection and analysis.

The system is designed to provide a clear view of the crystal growth process. It features a high-resolution camera and a computer interface that allows the user to monitor the growth of individual crystals in real-time. The system is easy to use and provides a wide range of options for data collection and analysis.

CrystalPro introduces a visualising protein experiments. The system is designed to provide a clear view of the crystal growth process. It features a high-resolution camera and a computer interface that allows the user to monitor the growth of individual crystals in real-time. The system is easy to use and provides a wide range of options for data collection and analysis.

The system is designed to provide a clear view of the crystal growth process. It features a high-resolution camera and a computer interface that allows the user to monitor the growth of individual crystals in real-time. The system is easy to use and provides a wide range of options for data collection and analysis.

CrystalPro introduces a visualising protein experiments. The system is designed to provide a clear view of the crystal growth process. It features a high-resolution camera and a computer interface that allows the user to monitor the growth of individual crystals in real-time. The system is easy to use and provides a wide range of options for data collection and analysis.

Bar & Restaurant with Sun Terrace  
 20m Indoor Pool, Spa & Sonarium  
 Over 100 Cardiovascular  
 & Resistance machines  
 Creche/Swimming Lessons  
 & Children's Hi 5 Club  
 Large Free Weights Area  
 Over 75 Classes Per Week  
 Free Internet Usage  
 Fully trained staff



**the finest fitness facilities in luton  
 who knows where it may lead?**



Exclusive Joining Fee - £25 for the first 25 applicants.  
 Offer expires 29th June 05 - Terms & conditions apply.

Call 01582 692046/7 for more details.  
 David Lloyd Luton,  
 Capability Green, Luton, Beds LU1 3LU  
 www.davidlloydleisure.co.uk



**David Lloyd**  
 feel the difference

**Join for just £20**

If you join with a partner, they will receive their first month free.

**01582 692046/7**

- Over 120 Cardiovascular & Resistance machines
- Over 75 Classes Per Week
- Large Free Weights Area
- Creche/Swimming Lessons
- Free Internet Usage
- Children's Hi 5 Club
- Bar & Restaurant
- 20m Indoor Pool
- Spa & Sonarium
- Fully trained staff

Over 100 Cardiovascular & Resistance machines  
 Creche/Swimming Lessons & Children's Hi 5 Club  
 Bar & Restaurant with Sun Terrace  
 20m Indoor Pool, Spa & Sonarium  
 Large Free Weights Area  
 Over 75 Classes Per Week  
 Free Internet Usage  
 Fully trained staff

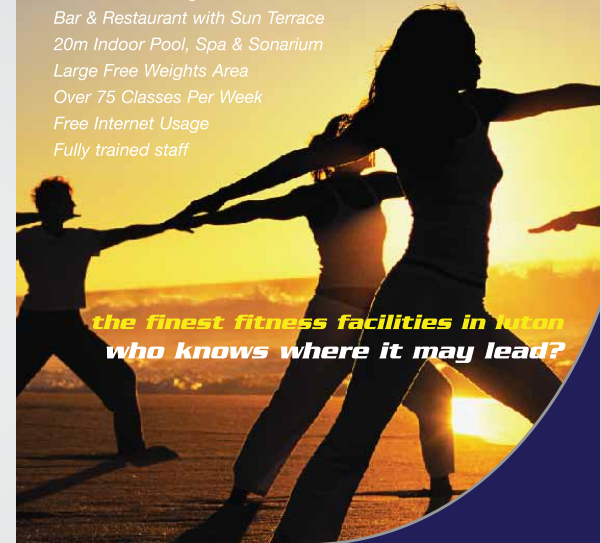

**the finest fitness facilities in luton  
 who knows where it may lead?**



Join by the end of June and receive a starter pack worth £45.  
 Offer available to first 50 applicants only - Terms & conditions apply.

Call 01582 692046/7 for more details.  
 David Lloyd Luton,  
 Capability Green, Luton, Beds LU1 3LU  
 www.davidlloydleisure.co.uk



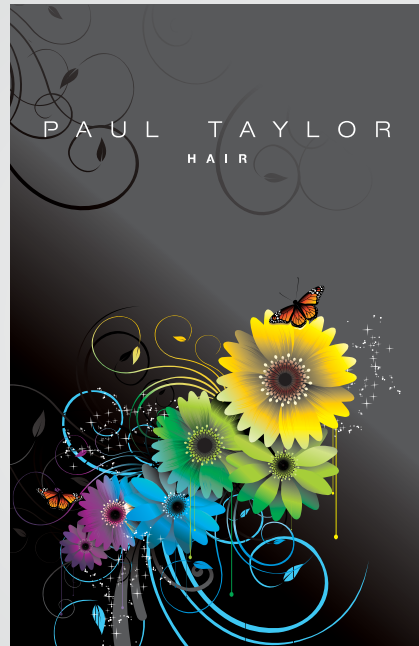

PAUL TAYLOR  
HAIR

Stylist

Time  Date

Time  Date

Time  Date

Time  Date

Time  Date

Time  Date

**01245 284880**



Appointment Card      01245 284880

Stylist.....

time.....	time.....
date.....	date.....
time.....	time.....
date.....	date.....
time.....	time.....
date.....	date.....

The graphic features the letters 'IDS' in a large, white, sans-serif font, centered over a grid of numerous small, colorful images. Below the grid, the text 'information display system' is written in a smaller, white, lowercase font. At the bottom of the graphic, the AVS logo (a circle with 'AVS' inside) is followed by 'Ascot Visual Solutions Limited' and the website 'www.avs-gb.co.uk'.

Information display system

THE BENEFITS

Keeping your operation up-to-date with fast, accurate messages dramatically improving performance and satisfaction.

**THE WOW FACTOR**

High-speed, high-tech, high-impact world, being the same just isn't good enough. Customers, current and future, feel that they have seen it all when it comes to signs, adverts and announcements.

**NOT THEM WRONG**

Expanding possibilities for getting your messages across to new and existing customers, text and audio to promote new products and reinforce branding. Create amazing, high-impact promotions quickly and easily.

Easy to create TV-quality presentations using a range of movie clips, images and audio to promote new products and reinforce branding.

Instant change content with a few clicks and make presentations more effective from web pages, news, weather and sport results.

**INFORMATION & PRODUCTIVITY**

Content tailored to every business need from single displays to multiple displays from TV, print, or Web.

Customized promotions around the content is displayed on the screen.

Spring station

Make the

and

ENTER 0800 025 212

01223 444444

www.avs-gb.co.uk

# Mrs. C's Bakery

Welcome to Mrs C's Bakery,  
home of the finest cupcakes in  
West Sussex.

Please take the time to explore  
my website to discover the  
amazing range of delicious  
cupcakes that I can freshly  
prepare for any occasion.

Mrs C. x



**Eurotech**  
automobiles

  
**Vasu Aggarwal**  
& Associates

**DASS**  
SECURITY SOLUTIONS

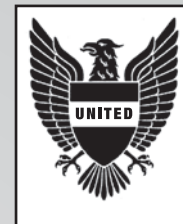

 **AL KAENAT**  
used electronics devices trading

  
**ARMOUR SECURITY**  
(India) Limited

 **Roberts Security Services**

**JANEEF**  
AUTO SERVICES

 **Security &  
Management Services**  
Limited

**GLOBAL**  
**security**  
consultants

  
robertsorientfzc

 **ALLIED  
SECURITY  
SERVICES LLC**

*Al Nashrah*  
trading establishment

**Technisource  
International**  
(Private) Limited **tgi**

 **synergy**  
establishment

 **ASLAM  
TRADING ESTABLISHMENT**

 **Roberts  
College**

 **OHI**  
POWER OF  
PARTNERSHIPS

**almisehal**   
CO LIMITED

  
**Al Talab**  
Electronics Devices Trading

  
**PRO  
GUARD**

PROGUARD SECURITY SERVICES LLC

 **SENTINEL**  
SECURITY SERVICES LIMITED

 **Talal Abu Ghazaleh**  
& Co. International

**Roberts Nippon 4x4**  
**AUTO SALES LIMITED MPV**

Client: Sulman Roberts  
Project: Multiple Logo Creation



Client: Ascot Visual Solutions Ltd.  
Project: Website Design & Authoring



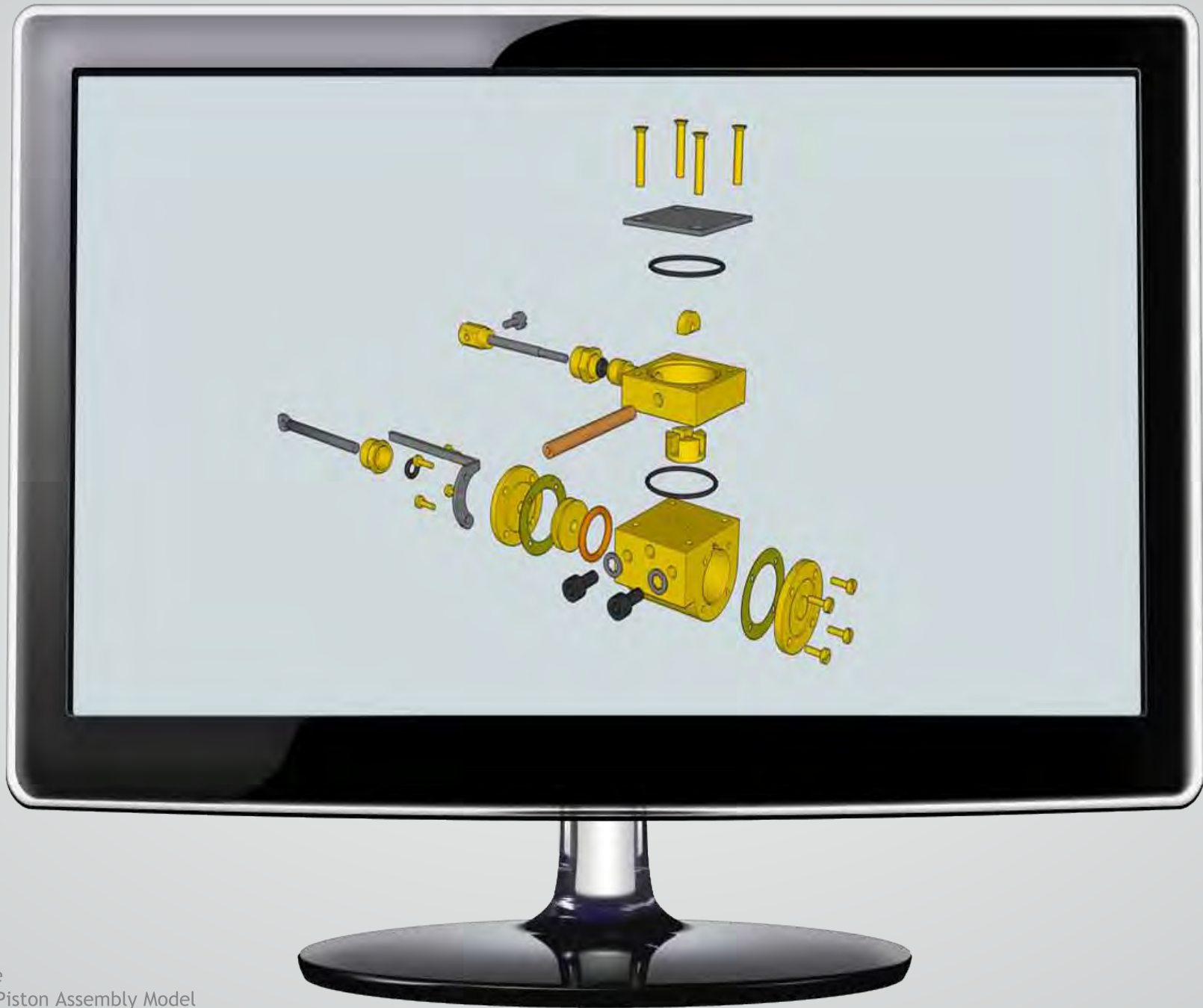

Client: Roundhouse  
Project: Exploded Piston Assembly Model



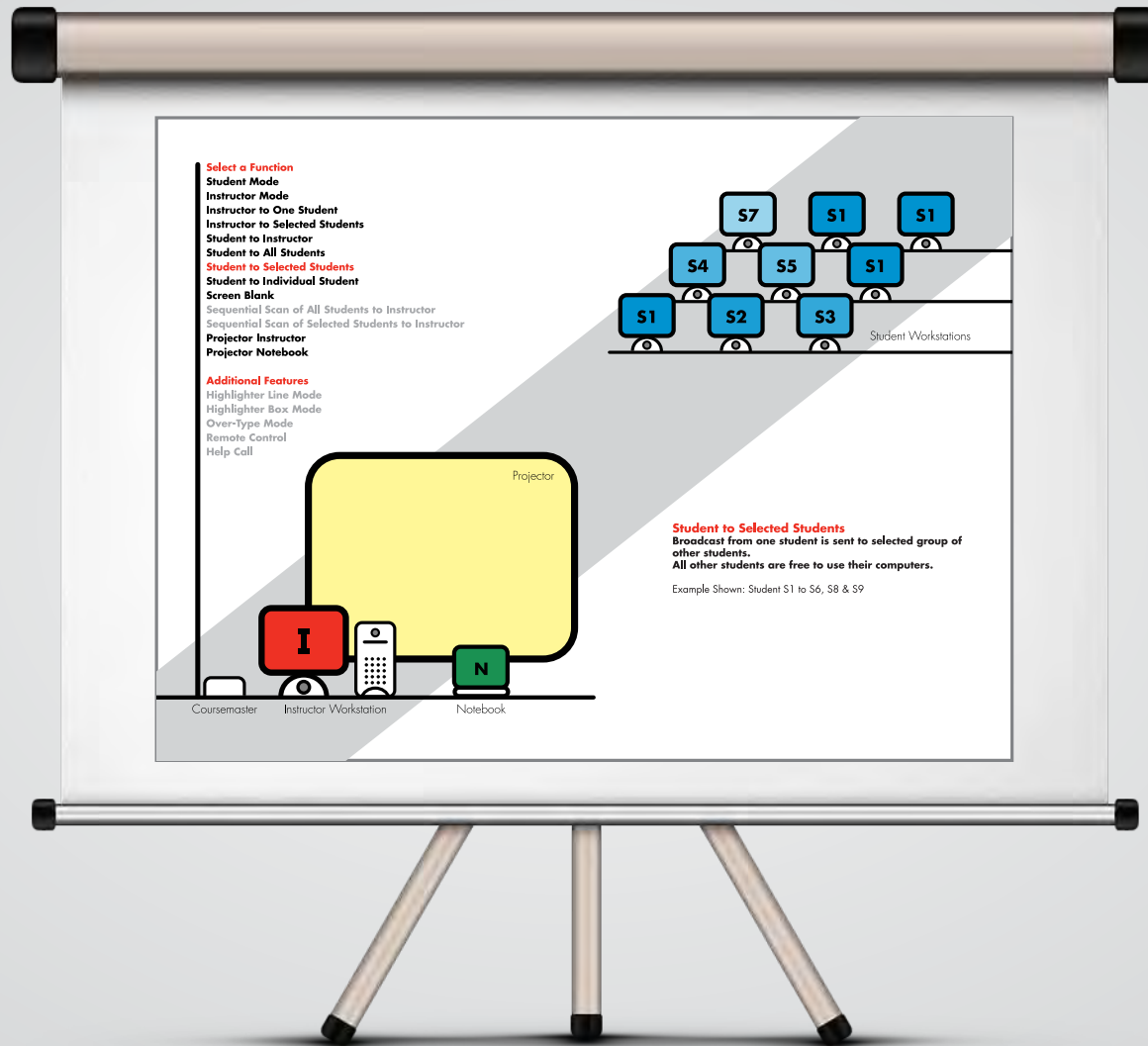

We help you save money, make money and free your time.

shions  
for all occasions



CARDNO™

Consumer Motorline

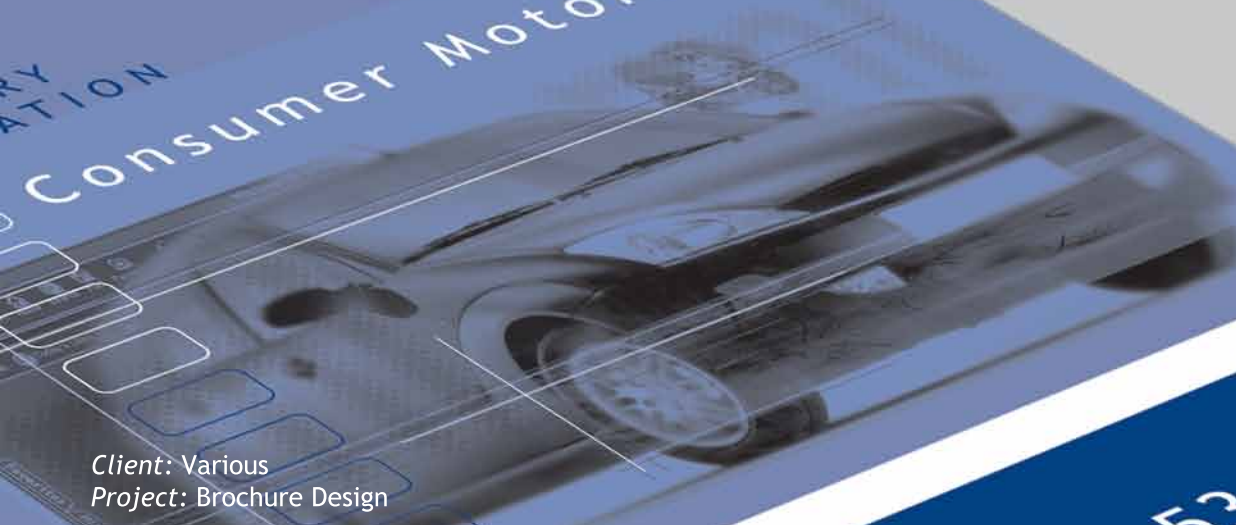

QUALITY Equipment & Hi

Client: Various  
Project: Brochure Design

11 7 58 53 50  
rest RMI member

SPECIAL VIBRATOR RANGE  
MOTORS

**David Byworth**

18 Medway Street  
Hallett Cove  
SA 5158

Tel: 0487 787 243  
Email: [david@bulletmedia.co.uk](mailto:david@bulletmedia.co.uk)

